

Custom Fabricated Nelex

Application:

Electric heating of paved surfaces such as sidewalks, driveways and parking ramps is an efficient, economical method of preventing snow and ice accumulation.

Electrical snow melting systems replace older, less efficient means of snow removal such as hot water or oil circulating systems, plowing or shovelling, and

offer an effective alternative to the application of salts and other chemicals which result in pavement damage and environmental pollution.

Nelex Mineral Insulated Cable:

Nelex mineral insulated cable is a high performance, industrial quality, series resistance heating cable which uses a high temperature metallic conductor as the heating element. The conductor is

insulated with an inorganic dielectric, Magnesium Oxide (MgO). The cable has a corrosion resistant Incoloy 825 outer sheath which provides mechanical protection and a ground path. Because of the

superior performance of Nelex MI cable, snow melting designs can use these advantages to reduce the overall cost and improve the reliability of the snow melting system.

Nelex Cable vs. Parallel, Self-Regulating Heaters:

Nelex MI cable has been used for snow melting systems for over 40 years, and offers several advantages over parallel, self regulating heater technology when used for snow melting systems.

Constant Wattage: Nelex cable provides a series resistance heating system so that the power output is uniform over the entire length of the cable. Parallel, self regulating heaters develop a significant voltage drop over their circuit length which results in reduced power output at the end of the circuit.

High Voltage: Nelex cable can be operated up to 600 volts while parallel, self regulating heaters are limited to 277 volts. Increased voltage results in longer circuit lengths and fewer circuits. In addition,

increased voltage correspondingly reduces amperage for an overall reduction of power distribution costs. And, at higher voltages, the need for step down transformers can be eliminated.

No Inrush: Nelex cable eliminates oversizing of circuit breakers because of cold temperature inrush. Most Nelex cable does not exhibit cold temperature inrush, and circuit breakers are sized for steady state load. Circuit breakers for parallel, self regulating heaters must be oversized to compensate for inrush.

High Power: Nelex cables can be operated up to 70 watts per foot. Because of the superior performance capabilities of Nelex cable, power outputs can be increased, which reduces the

amount of cable necessary for the required watt density. Parallel, self regulating cables are limited to 30-35 watts per foot, which results in narrower spacing and increased heater quantities.

Rugged Sheath: Nelex cables have a rugged, Incoloy 825 outer sheath which resists mechanical damage during installation. Parallel, self regulating heaters have plastic sheaths which are easily damaged during installation.

High Temperature Exposure: Nelex cables can withstand high temperatures, a requirement for installation in asphalt. Parallel, self regulating heaters are damaged by these temperatures.

Conduit Installation: Nelex cables can be installed inside conduit without deration of the heater. No additional cable is required if the cable is installed in conduit. Parallel, self regulating heater power output must be derated as much as 40% if installed in conduit, which increases the amount of cable required.

Design Options: Nelex cables are available in a wide variety of resistances and with either one or two conductors. More design choices allows the designer to provide the most economical heating solution, taking many design variable into consideration such as circuit length, voltage, and power distribution

requirements. Parallel, self-regulating heaters are limited to only one or two cable choices, with few options for design efficiency.

Nelex MI Cable Design Procedure:

For the most economical Nelex snow melting system, you will want to consider the following design guidelines:

Design Guideline

Maximize heater power output
Maximize heater spacing
Maximize voltage
Minimize amperage

Benefit

Reduced heater quantity
Reduced heater quantity
Longer circuits, fewer circuits
Lower power distribution costs

The following design procedure is based on providing the most economical snow melting system, using the advantages of Nelex MI cable. With this approach, cable power output and spacing are maximized.

Term	Units	Description
W	Watts/Ft ²	Desired Watt Density
V	Volts	Cable voltage
A	Ft ²	Surface Area for One Circuit
a	Amps	Total Circuit Amps
P	Watts/Ft	Cable Power Output
R	Ohms/Ft	Cable Resistance
L	Feet	Cable Circuit Length
S	Inches	Cable Spacing

Step 1: Select Desired Watt Density (W)

The ASHRAE "Systems Handbook" classifies snow melting systems as to the urgency for melting.

Class I (Minimum):

Residential walks or driveways and interplant areaways.

Class II (Moderate):

Commercial (stores and offices) sidewalks and driveways, and steps of hospitals.

Class III (Maximum):

Toll plazas of highways and bridges, and aprons and loading areas of airports

These classifications are based on the allowable rate of snow melting. Actual watt densities required depend on environmental conditions including air temperature, wind speed, snow fall rate, and snow coverage. The data in Figure-1 is taken from the recommendations and calculation methods provided in the ASHRAE handbook, and is intended to allow the designer to exercise some judgement based on risk factors.

Electric Snow Melting System Design Data:

COMMON WATT DENSITIES ACTUALLY INSTALLED (WATTS/FT ²)			
Location	Class I	Class II	Class III
Calgary, AB	45	55	65
Edmonton, AB	50	60	70
Little Rock, AR	20	30	50
Denver, CO	42	50	60
Wilmington, DE	30	40	50
District of Columbia	30-40	40-55	55-60
Mt. Home, ID	21	37	57
Chicago, IL	40	50	60
Indianapolis, IN	40	40	40-60
Dubuque, IA	40	40-60	60
Kansas City, KS	40	50	60
Ashland, KY	30	42	50
Bangor, ME	40	40	60
Baltimore, MD	30-45	50-60	60-75
Boston, MA	40-50	50-60	60-75
Detroit, MI	40-60	60	60
Minneapolis, MN	42-75	60-75	70-75
St. Louis, MO	40-60	40-60	60
Winnipeg, MB	40	50	60
Moncton, NB	35	45	55
Omaha, NE	40-45	60	60
Concord, NH	50	50	75
Atlantic City, NJ	30	40	60
New York, NY	35-40	40-50	50-60
Syracuse, NY	40-60	60	60
Charlotte, NC	42	30-42	42
Cincinnati, OH	40	50	60
Cleveland, OH	40	45	45-55
Ottawa, ON	45	55	65
Toronto, ON	35	45	55
Tulsa, OK	20	30	40
Montreal, PQ	45	60	60
Regina, SK	45	60	60

Figure 1

Step 2: Select Voltage (V)

Increased voltage reduces amperage and increases circuit length which reduces the overall cost of the snow melting system.

Step 3: Determine Area for Each Heat Tracing Circuit (A)

For large projects, the area corresponding to each heat tracing circuit can be based on maximum circuit amps which are limited by circuit breaker size. The Canadian and National Electrical Codes require the steady state circuit breaker load to be derated to 80% of the nominal circuit breaker rating. For example, the steady state load for a 40 amp breaker would be 80% of 40 or 32 amps. Alternately, a larger area can be divided

into smaller zones based on conduit and panel locations or expansion joint boundaries. A typical zone size is 200 square feet.

$$A = \frac{a \times V}{W} \quad \text{EQ-1}$$

$$a = \frac{P \times L}{V} \quad \text{EQ-2}$$

Step 4: Determine Maximum Cable Power Output (P)

Normally, you will want to maximize cable power output to minimize the amount of cable required. Nelex power outputs are limited by the pavement type and installation methods.

Pavement Type	Maximum Cable Output (P)
Asphalt	15 Watts/foot
Concrete	
Heater 2" deep:	40 Watts/foot
Heater 3" deep:	50 Watts/foot
Heater 4" deep:	60 Watts/foot
Heater 5" deep:	70 Watts/foot

Step 5: Determine Cable Circuit Length (L)

Cable circuit length in feet is given by the equation:

$$L = \frac{A \times W}{P} \quad \text{EQ-3}$$

Step 6: Determine Cable Spacing (S)

Cable spacing in inches (S) is given by the equation:

$$S = \frac{A \times 12}{L} \quad \text{EQ-4}$$

Step 7: Determine Cable Resistance (R)

Cable resistance in ohms/foot (R) is given by the equation:

$$R = \frac{V^2}{L^2 \times P} \quad \text{EQ-5}$$

Step 8: Select Cable

Use Figure-2 (located on the following page) to select the correct cable based on cable resistance and the desired number of conductors. When there is no corresponding cable with the exact resistance calculated in Step 7, select the cable with the resistance nearest to the calculated number. Selecting a cable with a higher resistance will decrease power output with the same circuit length while selecting a cable with a lower resistance will increase power output with the same circuit length.

Step 9: Finalize Design

Once you have selected the actual cable to be used, the design can be finalized.

Nelex Custom Cable Resistance Characteristics:

CABLE INSTALLED IN CONCRETE

2-CONDUCTOR CABLE 0.1875" DIAMETER INCOLOY, 300 VOLTS		
Cable Number	Cable Resistance (ohms/Ft)	
	Heating Design	Breaker Design
556K	.0459	.0425
658K	.0625	.0578
674K	.0804	.0741
693K	.1005	.0931
712K	.1281	.1188
715K	.1614	.1500
721K	.2153	.2122
732K	.3214	.3186
742K	.4184	.4141
752K	.5227	.5169
766K	.6667	.6582
774K	.7378	.7378
810K	1.0106	.9948
813K	1.2976	1.2976
818K	1.8156	1.8156
824K	2.3659	2.3659
830K	2.9730	2.9730
838K	3.7121	3.7121
846K	4.7586	4.7586
860K	5.5556	5.5556
866K	6.5200	6.5200
894K	9.0476	9.0476
919K	18.0667	18.0667

2-CONDUCTOR CABLE 0.3125" DIAMETER INCOLOY, 600 VOLTS		
Cable Number	Cable Resistance (ohms/Ft)	
	Heating Design	Breaker Design
588B	.0071	.0066
614B	.0151	.0139
627B	.0271	.0263
640B	.0400	.0394
670B	.0649	.0644
710B	.1040	.1030
715B	.1620	.1610
720B	.2057	.2043
732B	.3252	.3252
750B	.5000	.5000
774B	.7351	.7351
810B	1.1559	1.1559
819B	1.8553	1.8553
830B	2.9730	2.9730
840B	4.2581	4.2581
859B	6.0256	6.0256

Figure 2

Figure 2

Step 9: Finalize Design (continued)

Actual heater length in feet is given by Equation-6, where R is the actual resistance of the selected cable from Figure-2. The same equation can be used to fine-tune both the power output of the cable and circuit length:

$$L = \frac{V}{\sqrt{P \times R}} \quad \text{EQ-6}$$

Total circuit breaker load (a) in amps can be calculated from Equation-2 using the cable resistance given for circuit breaker sizing in Figure-2 as noted. Heater spacing is determined from Equation-4. Cable sheath temperature is determined from Figure-3 (next page).

Step 10: Specify Heater

Nelex MI cable is specified as per Catalog Ordering System on Page 5.

1-CONDUCTOR CABLE 0.1875" DIAMETER INCOLOY, 600 VOLTS		
Cable Number	Cable Resistance (ohms/Ft)	
	Heating Design	Breaker Design
145K	.0049	.0045
189K	.0097	.0090
216K	.0169	.0164
239K	.0393	.0389
250K	.0504	.0488
279K	.0796	.0789
310K	.0951	.0947
316K	.1579	.1569
326K	.2613	.2592
333K	.3309	.3309
346K	.4613	.4564
372K	.7320	.7320
412K	1.1810	1.1610
415K	1.4840	1.4840
423K	2.3780	2.3780
430K	2.7961	2.7961
447K	4.5000	4.5000

Figure 2

Catalog Ordering System:

Nelex Custom Cables

Catalog Number (*) A 670 B 150 07 (*)

(*)	A	670	B	150	07
Optional Construction	Form A or E from table	Conductor selection	Cable diameter K=.1875" B=.3125"	Hot section length in feet	Cold Section Length in feet

Optional Construction

Prefix	Suffix	Description
P		Pulling Eye for "A" form only
X		Oversized cold section or special feature
	UM	UL snow melting listing tag**

** Requires volts, amps and watts with each cable order.

MI CABLE SHEATH TEMPERATURE
In Concrete

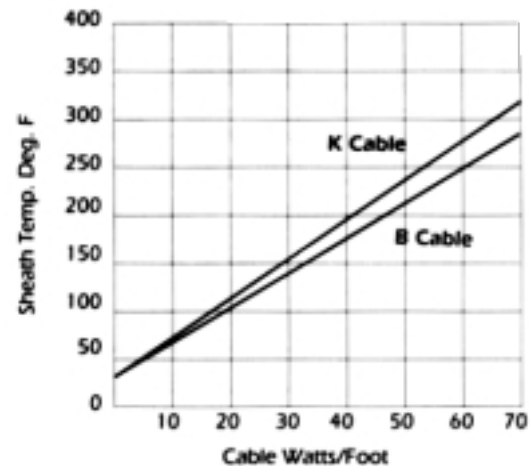

Figure 3

Note: Based on ambient temp of 30° F. Upper surface temperature of concrete will be approximately 1°F above ambient temperature for each cable W/F.

Control Methods:

There are three common methods for snow melting control. Each represents a trade off between installation costs and operating costs.

Manual Control: Manual control is the least expensive control system to install. But, because of its reliance on the human factor, a manual system may not be the most effective.

Ambient Control: Ambient control uses an ambient sensing thermostat to energize the snow melting system based on ambient temperature. This method can result in the system being operated under cold ambient temperatures, with or without the presence of moisture.

Automatic Snow Detector: The automatic system detects both low temperature and the presence of moisture, and energizes the snow melting system when both conditions are met. The automatic snow detection system eliminates the human error and provides the most economical and dependable solution to snow controls.

Controls and Accessories:

CATALOG	DESCRIPTION
HC4X50	Contactora, 50 amp, NEMA 4X enclosure
HC750	Contactora, 50 amp, NEMA 7 enclosure
OHC750	Contactora, 50 amp, oversized NEMA 7 enclosure
JBA	Cast Aluminum junction box, NEMA 4
SS05	Stainless tie wire
HCS-3	Clip strip, 3", 6" or 9" spacing
HCS-4	Clip strip, 4", 8" or 12" spacing
TA4X140	Ambient Thermostat, 15-140°F, NEMA 4X
TA7140	Ambient Thermostat, 15-140°F, NEMA 7

**RECOMMENDED METHODS FOR
CROSSING EXPANSION JOINTS**

1. POCKET DESIGN

- REDUCES POTENTIAL FOR SHEAR STRESS DAMAGE
- EXPANSION LOOP ABSORBS SLAB MOVEMENT
- USE IS FOR ON GRADE SLABS ONLY
- RECOMMENDED FOR THIN SLAB 2" OR LESS

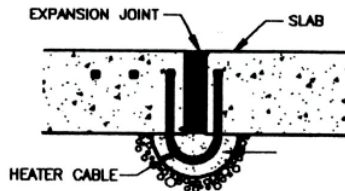

2. TUBE DESIGN

- REDUCES POTENTIAL FOR SHEAR STRESS DAMAGE
- PHYSICAL PROTECTION OF CABLE THRU JOINT
- HEATER EXPANSION LOOP ABSORBS SLAB SHIFT
- ADVANTAGEOUS FOR SINGLE POUR APPLICATION
- USE FOR ELEVATED Ac ON GRADE APPLICATIONS

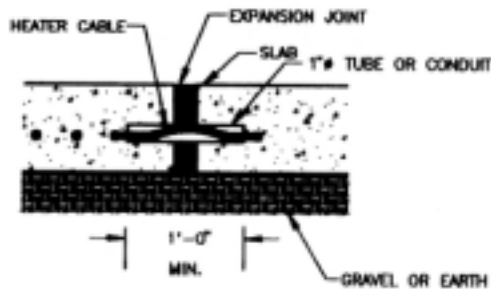

3. CHANNEL DESIGN

- REDUCES POTENTIAL FOR SHEAR STRESS DAMAGE
- PHYSICAL PROTECTION OF CABLE THRU JOINT
- HEATER EXPANSION LOOP ABSORBS SLAB SHIFT
- USE FOR ELEVATED & ON GRADE APPLICATIONS
- LOWER INSTALLATION COSTS

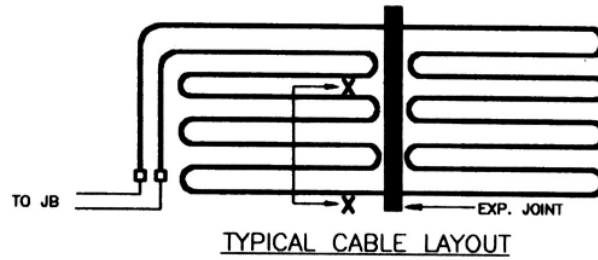
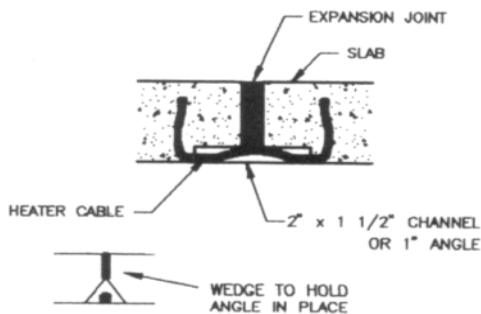

system in accordance with drawings, specifications and the equipment manufacturer's installation instructions.

2. The Mechanical Contractor shall provide a paving system that does not settle, heave, crumble, or crack so as to damage the heating equipment. Special consideration shall be given to reinforcing, expansion joints, paving and base materials, installation methods, and drying time. Chemical additives or dryers that are corrosive to cable's incoloy sheath shall not be used.
3. The Electrical Contractor shall:
 - a. Install factory assembled heating cables and controls of the catalog number, length, and arrangement shown on this drawing.
 - b. Assure that heater tags remain on each heater for identification after construction.
 - c. Care shall be taken to prevent damage to the heating cables during installation and paving. Any cable damaged during installation and paving shall be removed and a new cable installed.
 - d. Cable bends shall not be made within 3 inches of splice fitting and shall have a minimum radius of 2 inches.
 - e. Provide the architect with a written copy of:
 1. Pre-installation and post installation test for cable continuity and megger readings for insulation resistance.
 2. Start up test of voltage and current for each heating cable.
 3. As built drawing marked to show final arrangement of heating cable and sensor probes.
 - f. All wiring shall comply with the National Electric Code and local building codes.

Example Design Basis:

Voltage: 480 VAC
Watt Density: 50 Watts/Ft²
Cable: Single conductor, 600 volt

Burial Depth: 2 inches
Areas: See Construction drawings

Zone A:

Step 1 $W = 50 \text{ Watts/Ft}^2$

Step 2 $V = 480 \text{ volts}$

Step 3 $A = 180 \text{ Ft}^2$ (From Construction Drawing)

Step 4 $P = 40 \text{ Watts/Ft}$ (Maximum for 2" deep burial)

Step 5 $L = \frac{A \times W}{P} = \frac{(180) \times (50)}{40} = 225 \text{ Ft}$



Step 6 $S = \frac{A}{L} \times 12 = \frac{180}{225} \times 12 = 9.6 \text{ inches (Maximum)}$

Step 7 $R = \frac{V^2}{L^2 \times P} = \frac{(480)^2}{(225)^2 \times 40} = .1138 \text{ ohms/Ft}$

Step 8 From Figure 2, there are two choices in single conductor cable, 310K and 316K. We will select the 310K because of a closer fit (.095 ohms/Ft).

Step 9 $L = \frac{V}{\sqrt{P \times R}} = \frac{(480)}{\sqrt{(40) \times (.095)}} = 246 \text{ Ft (Actual)}$
 $S = \frac{A}{L} \times 12 = \frac{180}{246} \times 12 = 8.8 \text{ inches (9" nominal)}$
 $a = \frac{P \times L}{480} = \frac{40 \times 246}{480} = 20.5 \text{ amps}$

Step 10 Heater Designation = E 310K 246 07 07

<p>Approvals:</p> <p>Note: Cable voltage, Amps and watts</p>	<p>CSA Snow Melting</p> 	<p>UL Snow Melting (UM Suffix)</p> 
---	---	--

We are pleased to offer suggestions on the use of our various product, nevertheless, there are no warranties given except such expressed warranties offered in connection with the sale of a particular product. There are no implied warranties of merchantability or of fitness for a particular purpose given in connection with the sale of any goods. In no event shall Nelson Heat Tracing System's be liable for consequential, incidental or special damages. The Buyer's sole and exclusive remedy and the limit of Nelson Heat Tracing Systems' liability for any loss whatsoever shall not exceed the purchase price by the Purchaser for the product or products to which claim is made.

